

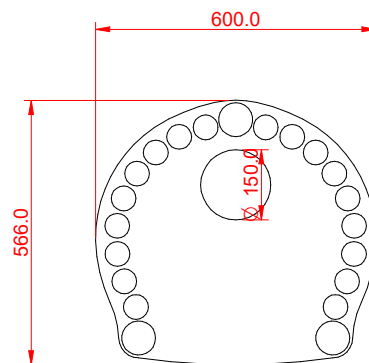

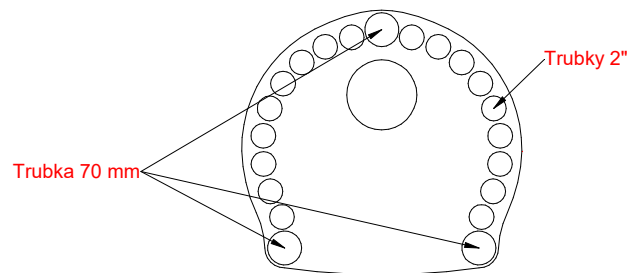



Kamna VLNA E 3



-  Žárobeton kterým jsou osazeny zadní, boční stěny a dno kamen
-  Sekundární vzduch
-  Oplach skla dvířek
-  Prim.vzduch
-  Spaliny

